

1

2

3

4

A

B

C

D

E

F

A

B

C

D

E

F

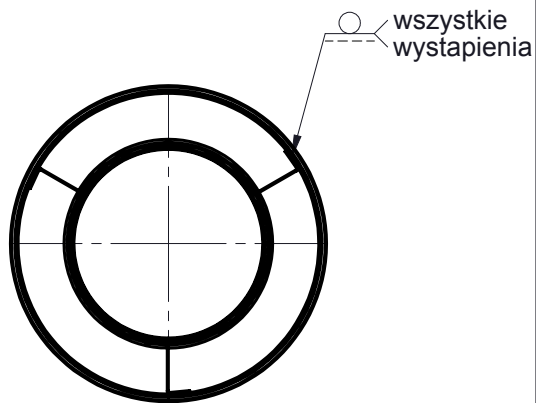

Dystans

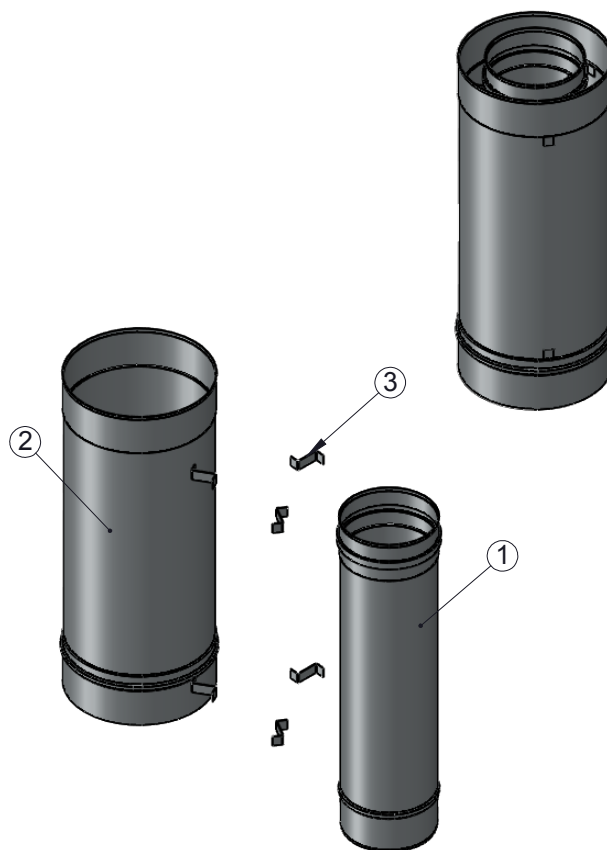
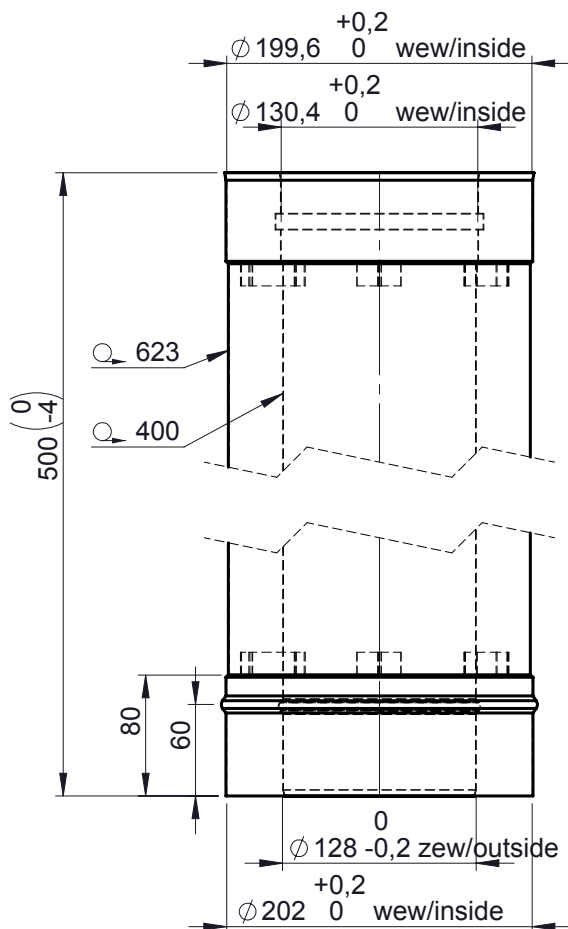
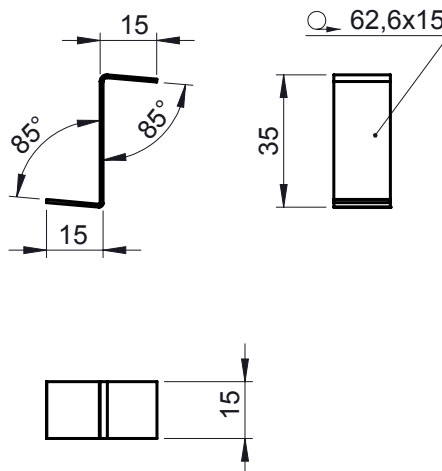

3	Dystans		1.4310 FS	0,8	0.01	6
2	DWA rura		1.4301 IIID	0,5	1.25	1
1	DWI rura		1.4301 IIIC	0,5	0.81	1
NO	NAME / DIN	NAV	MATERIAL	THICKNESS	WEIGHT [kg]	QTY

**Jeremias**  
CHIMNEY SYSTEMS

Material  
inside/outside

/

Description

Rura H-Twin 14  $\phi$  (130/200)

Weight

2.10

Date Name

drawn by 2016-11-21 JAD

checked by 2016-11-21 PSA

checked by

checked by

approved by 2016-11-21 JWY

Code  
**H-TWIN14C 130/200**

Production code

Project

Drawing no.

216 - 2075

Revision

- 00

Type

- 2P



Format

A4

Sheet

1 of 1

All dimensions without tolerances are produced according to Jeremias internal tolerances

All rights reserved

1

2

3

4